

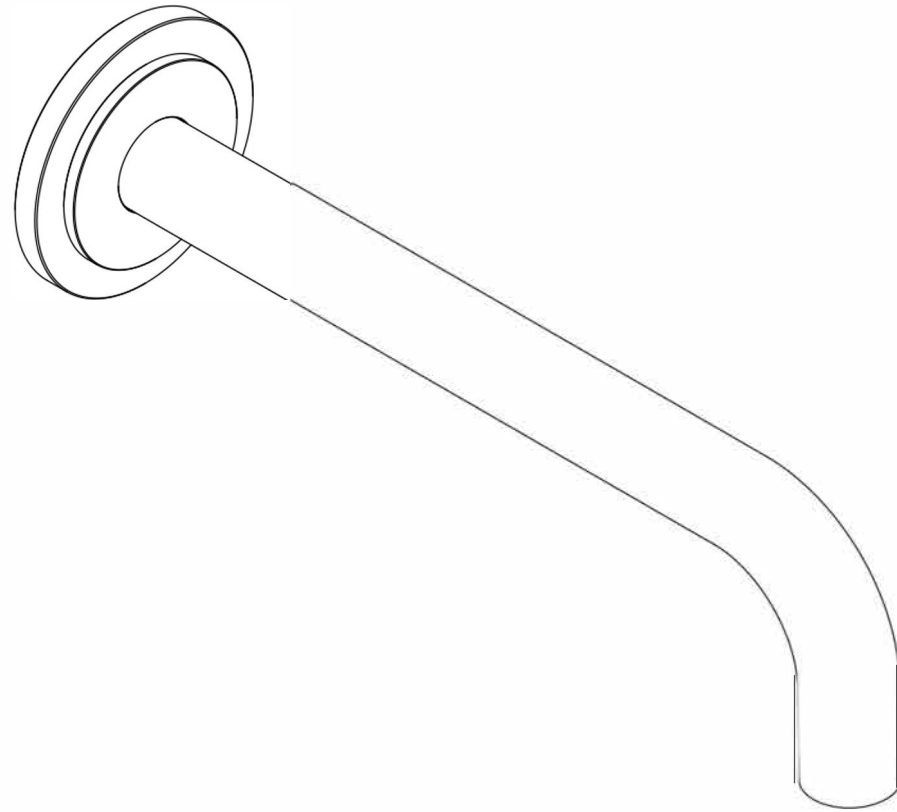

Technical Drawings & Product Specs
SP90_25

COCOON
www.bycocoon.com



SP90_25

COCOON
www.bycocoon.com

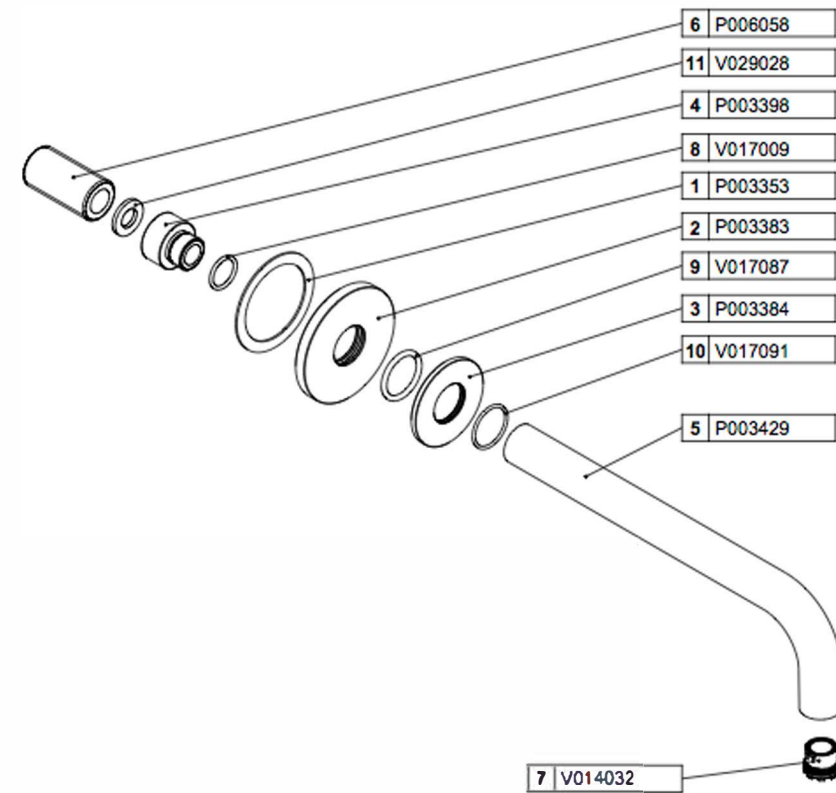
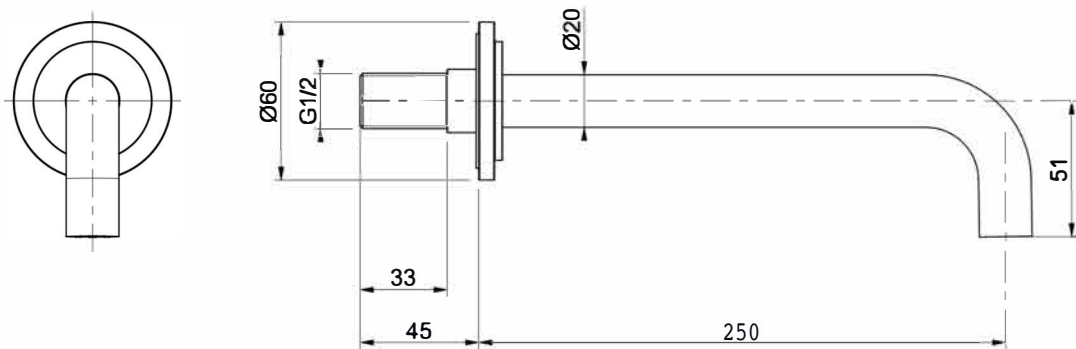

11	V029028	Guarnizione in fibra G1/2	1	FASIT202	0.963
10	V017091	O-Ring 1.5 x 20 ORM 0200-1.5	1	NBR_70_SH_A	0.179
9	V017087	O-Ring 2.62x20.63	1	EPDM	0.433
8	V017009	O-Ring corda 1.78x14	1	NBR_70_SH_A	0.185
7	V014032	Aeratore Neoperl cachè TT d.16.5	1	VARI	0.000
6	P006058	Gambo filettato G1/2 per canna lavabo tre fori COLEMAN	1	CW614N-M_EN-12164	74.785
5	P003429	Tubo bocca a muro d.20	1	ACCIAIO_INOX	253.695
4	P003398	Raccordo M16.5x1 M - G1/2 F	1	CW614N_EN12164	27.812
3	P003384	Rosone bocca a muro ø20	1	ACCIAIO_INOX_AISI_303	28.761
2	P003383	Rosone bocca a muro ø20	1	ACCIAIO_INOX_AISI_303	114.874
1	P003353	Guarnizione d.51 f.40 h.1	1	SPUGNA_ADESIVA	0.024
Pos.	Dis. nr.	Descrizione	Q.ta'	Materiale	Peso

SP90_25

COCOON
www.bycocoon.com